

## CARBON/SULFUR DETERMINATOR CS-800



### *Affordable Carbon and Sulfur Analysis by ELTRA*

- 4th Place Balance Included
- Reliable Printer
- Microprocessor Controlled
- Automatic Furnace Cleaning
- Compact Design
- Direct Reading
- Rapid Analysis
- Easy to Operate
- Low Maintenance
- Burnished Stainless Steel Cabinet

Thanks to Alpha you no longer have to pay as much for your carbon/sulfur determinator as you did for your home. The **CS-800 is affordably priced** and comes with **many desirable features** as standard equipment.

The CS-800 by ELTRA provides the **speed and accuracy** required for today's stringent demands. Both the furnace and electronic systems are contained in one space saving cabinet. Carbon and sulfur are simultaneously determined in about **50 seconds**. The unit comes complete with an interfaced **4th place balance** (0.0001 gm) resolution with a 100 gm capacity. This can yield **greater accuracy** with **automatic weight entry** as another standard feature.

The unit employs a high powered induction furnace (High Frequency) for rapid, complete sample combustion. A **16 bit microprocessor** controls the entire process along with 3 channel solid state I.R. detectors which deliver a signal **resolution of 0.1 ppm**. Four built in **calibration curves** are available and the instrument automatically switches from low to high carbon ranges when required for the sample analysis.

The CS-800 is **easy to operate**. The analysis is simply initiated by introducing the crucible containing the weighed sample and accelerator onto the pedestal. A touch of a switch **pneumatically inserts the specimen** into the high powered induction furnace and the analysis is completed in about **50 seconds**. The results are displayed on a large, **easy-to-read LCD screen** and **printed for hard copy**. The **furnace section is automatically cleaned** after each analysis.

**Additional features** such as graphic **peaks display**, **standard deviation calculations** and **data storage** can easily be accomplished by connecting the output of the CS-800 to your PC. Single element (carbon or sulfur) units are also available.

**Because of Alpha**, your **obsolete LECO® equipment now has value**. Realize **further savings** by **trading in your obsolete LECO® equipment**. **Call Alpha today** for more information. **Toll Free 1-800-833-3083**.

VISIT US AT: [WWW.ALPHARESOURCES.COM](http://WWW.ALPHARESOURCES.COM)

YOU MAY BEGIN PLACING ORDERS ONLINE BEGINNING JANUARY 1, 2003!!!

## USED LECO® EQUIPMENT & TRADE IN POLICY



### THANKS TO ALPHA YOUR OLD LECO® EQUIPMENT NOW HAS VALUE!

Alpha routinely accepts trade-in instrumentation on the sale of new Alpha instruments. Much of this is still in very good working order. Alpha's skilled service technicians thoroughly check out and operate these units, which then are offered for resale at **bargain prices**. The supply is limited and is constantly changing - it is impossible to publish an accurate list of used equipment that is available. If you are looking for a particular piece of equipment, we suggest you contact . . .

ALPHA TODAY AT 1-800-833-3083



### CAN'T FIND THE SPARE PART YOU NEED FOR YOUR OBSOLETE LECO® EQUIPMENT?

Alpha maintains an inventory of some **obsolete supplies and electronic parts** for both your new and old LECO® instruments. If you require spare parts, and know the LECO® part number, please **give our helpful service department a call at 269-465-3758**



# HARDNESS TEST BLOCKS AND SUPPLIES

All Alpha Resources, Inc. Brinell Test Blocks come certified to applicable standards. We adhere to a strict procedure for our calibration process, and the accuracy of our tester is maintained using a proving ring and load cell both traceable to N.I.S.T. The readings themselves are done using a stage micrometer also calibrated and traceable to N.I.S.T.

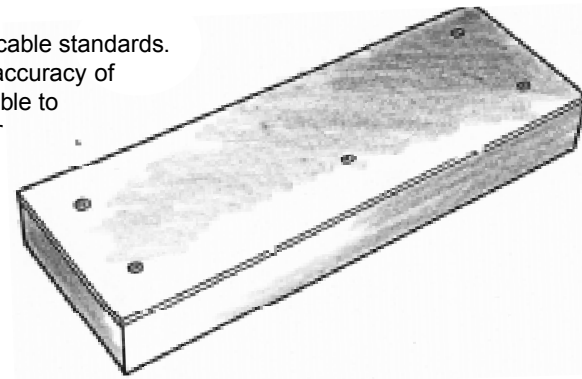

**All of our  
Hardness Test Blocks  
come with certification  
to all applicable standards**

BRINELL HARDNESS TEST BLOCK & ACCESSORIES		
PART NO.	DESCRIPTION	
AM4033	3000 Kg Load 10mm Ball	All Hardness Ranges
AM4032	2000 Kg Load 10mm Ball	All Hardness Ranges
AM4031	1500 Kg Load 10mm Ball	All Hardness Ranges
AM4030	1000 Kg Load 10mm Ball	All Hardness Ranges
AM4029	500 Kg Load 10mm Ball	All Hardness Ranges
AM4028	250 Kg Load 10mm Ball	All Hardness Ranges
AM4027	187.5 Kg Load 10mm Ball	All Hardness Ranges
AM4026	Telebrinell Test Blocks	
AM4025	10mm Carbide Balls	
AM4024	10mm Steel Balls	



We manufacture our micro hardness test blocks to exceed industry standards. All of our micro test blocks are mirror-polished and mounted to provide the best possible test surface.

Each mirror-polished Heavy Load Vickers test block has the same surface area provided by our Rockwell test blocks, so that you get the most test opportunities for your money.

MICRO HARDNESS TEST BLOCK & ACCESSORIES		
PART NO.	DESCRIPTION	
AM4019	Vickers (1 gram to 1,000 gram)	All Ranges
AM4020	Heavy Load Vickers (1 Kg to 50 Kg)	All Ranges
AM4021	Knoop (1 gram to 1,000 gram)	All Ranges
AM4022	Vickers Diamond Penetrator	
AM4023	Knoop Diamond Penetrator	

Note: When ordering please specify Knoop or Vickers, Load and the Hardness Number you require.

Alpha Resources, Inc. Calibration Kits are produced to provide our customers with the ultimate tool in Quality Control. Each kit contains a test block or blocks and the actual penetrator unit that was used to calibrate them. By matching specific blocks to a specific penetrator, a set relationship is established and they can be eliminated as potential variables in the hardness test system. Should a problem arise, a master kit on hand allows you to quickly and accurately determine whether your hardness tester is the source.

Each block in our kits has been calibrated on a tester whose accuracy has been verified using N.I.S.T. traceable load and depth measuring devices. The individual test blocks are marked both with their own unique serial number AND the serial number of the penetrator in the kit. All of our kits come with their own polished wood case, and certified to all the applicable standards.

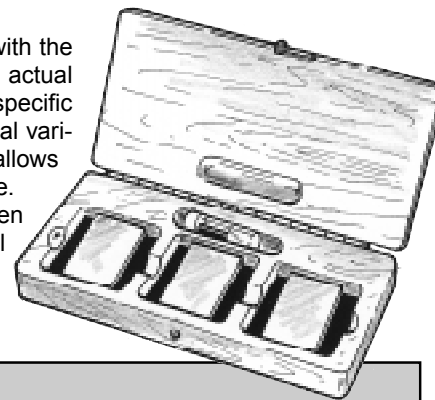

MASTER CALIBRATION KITS								
C SCALE with C DIAMOND PENETRATOR		B SCALE with B DIAMOND PENETRATOR			C and N SCALE STEEL with C DIAMOND and N DIAMOND PENETRATOR		COMBINATION C SCALE and B SCALE	
PART NO.	DESCRIPTION	PART NO. 1/16" BALL PENETRATOR	PART NO. 1/8" BALL PENETRATOR	DESCRIPTION	PART NO.	DESCRIPTION	PART NO.	DESCRIPTION
AM4087	1 Block	AM4092	AM4097	1 Block	AM4102	6 Blocks	AM4105	6 Blocks
AM4088	3 Blocks	AM4093	AM4098	3 Blocks	AM4103	10 Blocks	AM4106	10 Blocks
AM4089	6 Blocks	AM4094	AM4099	6 Blocks	AM4104	20 Blocks	AM4107	20 Blocks
AM4090	10 Blocks	AM4095	AM4100	10 Blocks				
AM4091	20 Blocks	AM4096	AM4101	20 Blocks				

# TABLE OF CONTENTS

<b>SECTIONING</b>	<b>GRINDING</b>	<b>MOUNTING</b>
Abrasive Cut-off Wheels ..... 5-6	Belts, Aluminum Oxide ..... 11	Cold Mounting Materials,
Cutting Supplies ..... 6	Belts, Silicon Carbide ..... 11	Acrylics & Epoxys ..... 10
Diamond Wafering Blades ..... 7	Belts, Zirconia Alumina ..... 11	Diallyl Phthalate Powders ..... 9
Indestructible Cut-off Wheels ..... 5	Disc, AlphaGrab® ..... 15	Fina-met ..... 9
Miniature Abrasive Cut-off Wheels ..... 7	Disc, Diamond Grinding ..... 7	Mold Cups ..... 9
	Discs, Aluminum Oxide ..... 19	Mounting Supplies ..... 9
<b>DIAMOND POLISHING SUPPLIES</b>	Discs, Silicon Carbide ..... 15-18	Phenolic Powders ..... 9
Diamond Compounds, Syringe ..... 22	Discs, Zirconia Alumina ..... 18	Phenolic Preforms ..... 8
Diamond Lapping Films ..... 21	Rolls, Silicon Carbide ..... 11	Transparent Lucite® ..... 9
Diamond Polishing Lubricant ..... 24	Strips, Silicon Carbide ..... 14	
Diamond Pump Spray ..... 23		<b>MICROHARDNESS TESTING SUPPLIES</b>
Diamond Slurry ..... 23		Anvils ..... 26
Polishing Cloths ..... 20		Ball Penetrators ..... 25
	<b>ADDITIONAL INFORMATION</b>	Master Calibration Kits ..... 26
<b>POLISHING</b>	Cross Reference,	Test Blocks, Brinell Hardness ..... 26
Aluminum Oxide Microfinishing Film ..... 21	Alpha/LECO®/Buehler® ..... 12-13	Test Blocks, Micro Hardness ..... 26
Polishing Cloths ..... 20	Grit Comparison Guide ..... 19	Test Blocks, Rockwell Regular ..... 25
Polishing Powders ..... 24	Letter to Our Customers ..... 4	Test Blocks, Rockwell Superficial ..... 25
Polishing Suspensions ..... 24	New ELTRA Instruments ..... 2	Testing Accessories ..... 25-26
	Quantity Discount Schedule ..... 4	
	Used LECO® Instruments ..... 27	

## ORDERING INFORMATION AND GENERAL TERMS

Contact us at:

Toll Free (USA only) ..... 1-800-833-3083  
 Phone ..... 1-269-465-5559  
 Fax ..... 1-269-465-3629  
 Email ..... alphares@aol.com  
 Web page ..... www.alpharesources.com

To quickly and correctly place your order, please provide us with the following information:

Correct Shipping and Billing address  
 Name of Contact person  
 Telephone and Fax number  
 Part number and unit of measure for each item  
 Purchase order number  
 Method of shipment (see below)

**Ordering Online:** Beginning January 1, 2003, Alpha Resources will be able to accept your purchase orders online. You will be able to issue a purchase order and get current pricing while placing the order. You are encouraged to visit our new web page to save time when placing your orders.

**Payment Terms:** Alpha Resources has a \$25.00 minimum purchase order requirement. Alpha Resources terms are Net 30 with approved credit. New customers will need to submit credit references when they place their first order to be set up on Net 30. We will also accept payment by Visa, MasterCard or American Express.

**Shipping Method:** FOB shipping point is Stevensville, MI. Alpha Resources is pleased to provide its customer with UPS shipping. We will attempt to ship all regular orders within a period of 5 days from the date the order is received. We also have available UPS Red (next day), UPS Blue (second day) and UPS Orange (third day) shipping. You will need to specify these methods when you place your order. If you would like us to use any other shipping company, you will need to provide us with your account number when you place the order and the material will be shipped collect.

**Damaged Goods:** If the shipping container is damaged, refuse delivery and notify the carrier. If concealed and the material is damaged, you will need to contact the carrier for them to come in and inspect the material.

**Returning Material:** To return goods for any reason, you must obtain a Returned Goods Authorization (RGA) number. To obtain this, simply contact Alpha Resources. Items ordered in error or returned at customers request may be subject to a 15% restocking fee. Credit may be issued for materials which are unopened and undamaged.

**MSDS:** Material Safety Data Sheets (MSDS) are available for all Alpha products. You may obtain these by visiting our web page and downloading the file. You may also contact us directly and we will be happy to send them to you.

**Disclaimer:** Alpha products are intended for use in a laboratory environment. They are not intended for use in the home or for other applications. It is the customer's responsibility to store, handle, properly use and dispose of all products purchased from Alpha Resources, Inc. Our prices are subject to change without notice. Customers should contact Alpha to obtain current pricing.



# HARDNESS TEST BLOCKS AND SUPPLIES



We offer the **LARGEST** in stock selection of **ROCKWELL TEST BLOCKS** IN THE INDUSTRY.

If you don't see what you are looking for, call **ALPHA** today at 1-800-833-3083

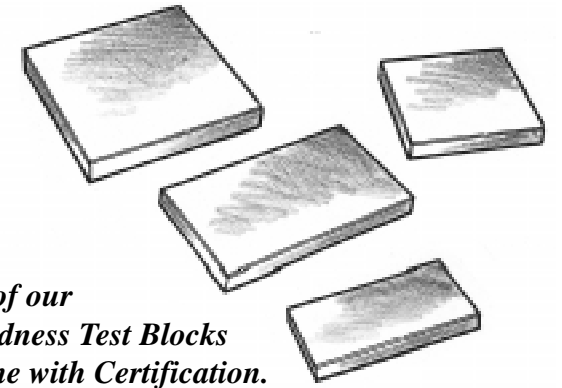

All of our **Hardness Test Blocks** Come with **Certification**.

## ROCKWELL REGULAR TEST BLOCKS

PART NO.	HARDNESS SCALE	PENETRATOR	LOAD	RANGES	MATERIAL
AM4000	A Scale	C Diamond	60 Kg.	A60-A84	Steel
AM4001	A Scale	C Diamond	60 Kg.	A20-A59	Brass
AM4002	A Scale	A Diamond (Carbide)	60 Kg.	A88 & up	Carbide
AM4003	B Scale	1/16" Ball	100 Kg.	B10-B92	Brass
AM4004	B Scale	1/16" Ball	100 Kg.	B90-B130	Steel
AM4005	C Scale	C Diamond	150 Kg.	All	Steel
AM4006	D Scale	C Diamond	100 Kg.	All	Steel
AM4007	E Scale	1/8" Ball	100 Kg.	All	Brass
AM4008	F Scale	1/16" Ball	60 Kg.	All	Brass
AM4009	G Scale	1/16" Ball	150 Kg.	G2.5-G64	Brass
AM4010	G Scale	1/16" Ball	150 Kg.	G66 & up	Steel
AM4011	H Scale	1/8" Ball	60 Kg.	All	Brass
AM4012	K Scale	1/8" Ball	150 Kg.	All	Brass
AM4013	L Scale	1/4" Ball	60 Kg.	All	Brass
AM4014	M Scale	1/4" Ball	100 Kg.	All	Brass
AM4015	P Scale	1/4" Ball	150 Kg.	All	Brass
AM4016	R Scale	1/2" Ball	60 Kg.	All	Brass
AM4017	S Scale	1/2" Ball	100 Kg.	All	Brass
AM4018	V Scale	1/2" Ball	150 Kg.	All	Brass

## ROCKWELL SUPERFICIAL TEST BLOCKS

PART NO.	HARDNESS SCALE	PENETRATOR	LOAD	RANGES	MATERIAL
AM4034	15N Scale	N Diamond	15 Kg.	All	Steel
AM4035	30N Scale	N Diamond	30 Kg.	All	Steel
AM4036	45N Scale	N Diamond	45 Kg.	All	Steel
AM4037	15T Scale	1/16" Ball	15 Kg.	All	Brass
AM4038	30T Scale	1/16" Ball	30 Kg.	All	Brass
AM4039	45T Scale	1/16" Ball	45 Kg.	All	Brass
AM4040	15W Scale	1/8" Ball	15 Kg.	All	Brass
AM4041	30W Scale	1/8" Ball	30 Kg.	All	Brass
AM4042	45W Scale	1/8" Ball	45 Kg.	All	Brass
AM4043	15X Scale	1/4" Ball	15 Kg.	All	Brass
AM4044	30X Scale	1/4" Ball	30 Kg.	All	Brass
AM4045	45X Scale	1/4" Ball	45 Kg.	All	Brass
AM4046	15Y Scale	1/2" Ball	15 Kg.	All	Brass
AM4047	30Y Scale	1/2" Ball	30 Kg.	All	Brass
AM4048	45Y Scale	1/2" Ball	45 Kg.	All	Brass

NOTE: Aluminum Test Blocks are available in "B", "E", "F", "G", "H", "K" Scales, but ranges are more limited.



### DIAMOND PENETRATORS

Each diamond penetrator is mounted in conformity with its grain structure, to assure balanced pressure and prevent early wear or breakage. They are precision ground, lapped and polished. We also subject each diamond penetrator to a strict performance test before it is approved for sale.

## ROCKWELL TESTING ACCESSORIES

PART NO.	DESCRIPTION	PART NO.	DESCRIPTION
AM4049	Standard "C" Diamond Penetrator	AM4054	'Indentron' - type "C" Diamond
AM4050	Standard "N" Diamond Penetrator	AM4055	'Indentron' - type "N" Diamond
AM4051	Carbide "A" Diamond Penetrator	AM4056	"C" & "N" Combo
AM4052	'Versitron' - type "C" Diamond		Slip-in Diamond Penetrator
AM4053	'Versitron' - type "N" Diamond	AM4057	"C" Portable Diamond Penetrator
		AM4058	'Versitron' - type Tapered Diamond



BALL PENETRATORS

### BALL PENETRATORS

PART NO.	DESCRIPTION
AM4059	1/16" Ball Penetrator Unit
AM4060	1/16" Balls (50 each)
AM4061	1/8" Ball Penetrator Unit
AM4062	1/8" Ball (25 each)
AM4063	1/4" Ball Penetrator Unit
AM4064	1/4" Balls
AM4065	1/2" Ball Penetrator Unit
AM4066	1/2" Balls
AM4067	1/16" Carbide Balls

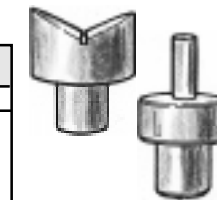

ANVILS

### ANVILS

PART NO.	DESCRIPTION
AM4068	Pedestal Spot (1/4") Anvil
AM4069	1 1/2" Flat Anvil
AM4070	2 1/2" Flat Anvil
AM4071	Shallow "V" Anvil
AM4072	Standard "V" Anvil
AM4073	3 1/2" "V" Anvil
AM4074	4" "V" Anvil
AM4075	Gooseneck Anvil
AM4076	Diamond Spot Anvil

## OTHER ACCESSORIES

PART NO.	DESCRIPTION	PART NO.	DESCRIPTION	PART NO.	DESCRIPTION
AM4078	Index Adjusting Unit	AM4081	Dash Pot Oil (1/2 Pint)	AM4084	Jack Rest (8" or 12")
AM4079	Cross Pin Unit (For Dials)	AM4082	Gooseneck Adapter 2 1/2"	AM4085	Extension Support
AM4080	Elevating Unit Oil (1/2 Pint)	AM4083	8" Testing Table	Am4086	Bulbs

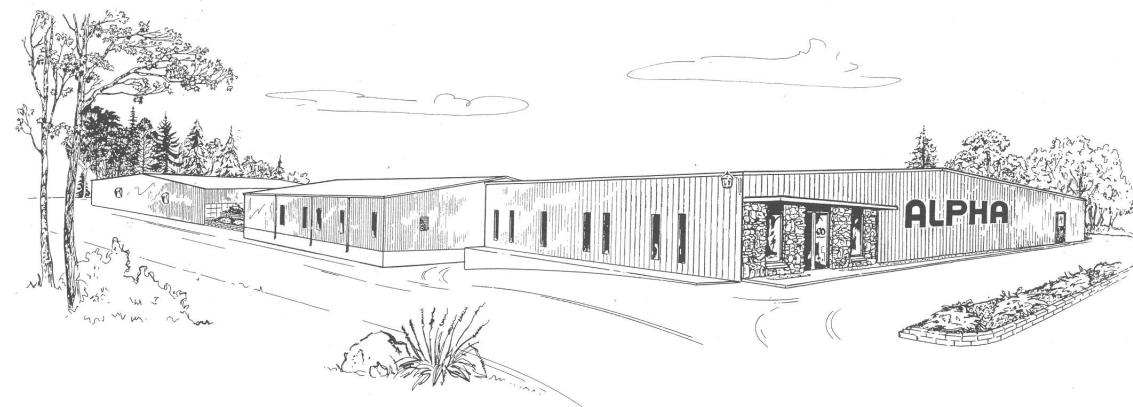

Alpha's presence in the marketplace has helped control unjustified price increases and has caused price reductions by our competition. Many of you have benefited by this healthy condition. Now, Alpha Resources, Inc. asks you to help us by sharing your needs with us. We appreciate your business and feel that you should **not PAY MORE** and that **YOU NEED US** as much as we need you. Thanks for your continued support.

# POLISHING MATERIALS

## ALCRON® DIAMOND SUPPLIES



DESCRIPTION	UNIT	CATALOG NO.
Diamond Lubricant, WS	Pt.	AM1002
Diamond Lubricant, WS	Qt.	AM1003
Diamond Lubricant, WS	Gal.	AM1004
Diamond Lubricant, OS	Pt.	AM1006
Diamond Lubricant, OS	Qt.	AM1007
Diamond Lubricant, OS	Gal.	AM1008
Atomizer Applicator	Ea.	AM1031
Plastic Squeeze Bottle	250 ml.	AM0996

WS - Water Soluble OS-Oil Soluble

## LIQUID POLISHING SUSPENSIONS

Available in convenient 6 oz. (177 ml.) dispenser bottles



DESCRIPTION	MICRON SIZE	UNIT	CATALOG NO.
Alumina Suspension	5.0	6 oz.	AM0825
Alumina Suspension	5.0	gal.	AM0825G
Alpha Alumina*	1.0	6 oz.	AM0832
Alpha Alumina*	1.0	gal.	AM0818
Alpha Alumina*	0.3	6 oz.	AM0827
Alpha Alumina*	0.3	gal.	AM0834
Alpha Alumina*	0.1	6 oz.	AM0833
Alpha Alumina*	0.1	gal.	AM0835
Gamma Alumina*	0.05	6 oz.	AM0826
Gamma Alumina*	0.05	gal.	AM0665
Chromic Oxide	1-3	6 oz.	AM0828
Chromic Oxide	0.5	6 oz.	AM0829
C-RO	.05	6 oz.	AM0830
Cerium Oxide	1.0	6 oz.	AM0831
Master Polish Aqueous Colloidal High pH SiO <sub>2</sub>	0.06	32 oz. gal.	AM1022 AM1022S

\*Indicates Agglomerate-Free Suspensions

## ALUMINUM OXIDE

Available in 1 Lb. (.454 kg) • 5 Lb. (2.27 kg)



DESCRIPTION	MICRON SIZE	UNIT	CATALOG NO.
Alpha C	1.0	1 Lb.	AM0786
Alpha C	1.0	5 Lb.	AM0787
Alpha A	0.3	1 Lb.	AM0782
Alpha A	0.3	5 Lb.	AM0783
Gamma B	0.05	1 Lb.	AM0778
Gamma B	0.05	5 Lb.	AM0779

## MAGNESIUM OXIDE

DESCRIPTION	MICRON SIZE	UNIT	CATALOG NO.
MgO	2.0	1 Lb. (.454 kg)	AM0788

# ABRASIVE CUT-OFF WHEELS

To the metallurgist, the quality of the cut should be paramount and the wheel life secondary. Abrasive cutting provides one of the best solutions to minimize heat and deformation. To cut properly, a bonded abrasive wheel should be matched to the cut-off machine. Alpha's abrasive cut-off wheels are used to section ferrous, non-ferrous, stainless steel, titanium, rocks, glass and other materials.

All of Alpha's wheels are rubber bonded. To cut clean and fast, the bond should break down rapidly and expose fresh grains. Hard wheels are strongly bonded and more tenaciously hold each abrasive grain while soft wheels readily break down and release abrasive particles. A soft bond should be used to section hard materials, while a hard bond should be used to section soft materials. Typical abrasive particles are Aluminum Oxide and Silicon Carbide.

It is important to properly cool the sample as it is cut. This can be done by submerged or jet-spray cooling.



**IMPTECH C-10**  
Abrasive Cutting Saw  
ALPHA Part Number C10001

## INDESTRUCTIBLE CUT-OFF WHEEL

**Reinforced, Diamond Impregnated, SiC** on a Fiberglass mesh base helps make this flexible wheel **almost indestructible** and long lasting. A metallurgical cut can be obtained by using ample cooling water. The wheels have been sprayed to minimize flexing and help assure a straight cut. This wheel is **almost impossible to break** and will virtually eliminate breakage. This remarkable wheel can **easily cut a wide variety of materials** including **ceramics, tool steel, aluminum, titanium, acrylics and other materials.**

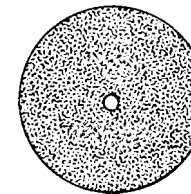

WHEEL SIZE	THICKNESS/DESCRIPTION	CATALOG NO.
AM1105 10 Inch (254 mm) with 1.25 Inch (32 mm) Arbor Hole x .085 Inch Kerf		AM1105
AM1103 10 Inch (254mm) with 0.50 Inch (12 mm) Arbor Hole x .085 Inch Kerf		AM1103

The **Arbor Hole** can easily be enlarged to accept other arbor sizes between 12 mm and 32 mm. Sold individually with **discounts for quantity**. Try this **indestructible wheel** to help reduce wheel breakage wastes. Priced each at **only \$15.00** or in single releases of **10 wheels for \$125.00**.

## ABRASIVE CUT-OFF WHEELS

12 Inch (305 mm) with 1.25 Inch (32mm) Arbor Hole Wheels Sold in 10/Pkg. Only

RECOMMENDED USE	ABRASIVE	THICKNESS	CATALOG NO.
Rc 60+ Hardened	Al <sub>2</sub> O <sub>3</sub>	.070 Inch (1.8mm)	AM1065
Rc 45-60 Hardened	Al <sub>2</sub> O <sub>3</sub>	.070 Inch (1.8mm)	AM1081
Rc 45-60 Large Samples	Al <sub>2</sub> O <sub>3</sub>	.063 Inch (1.6mm)	AM1083
Rc 30-45 Medium Hard	Al <sub>2</sub> O <sub>3</sub>	.070 Inch (1.8mm)	AM1089
Rc 25-35 Medium Soft	Al <sub>2</sub> O <sub>3</sub>	.070 Inch (1.8mm)	AM1095

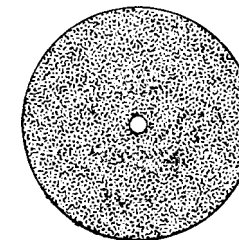

Hard Non-ferrous Rocks & Glass Etc.	SiC	.062 Inch (1.6mm)	AM1066
Zirconium, Titanium Uranium, etc.	SiC	.063 Inch (1.6mm)	AM1104



## ABRASIVE CUT-OFF SUPPLIES

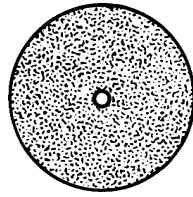

10 Inch (254 mm) with 1.25 Inch (32 mm) Arbor Hole		Wheels Sold in 10/Pkg. Only	
RECOMMENDED USE	ABRASIVE	THICKNESS	CATALOG NO.
Rc 60+ Hardened	Al <sub>2</sub> O <sub>3</sub>	.070 Inch (1.8mm)	AM1059
Rc 45-60 Hardened	Al <sub>2</sub> O <sub>3</sub>	.070 Inch (1.8mm)	AM1061
Rc 45-60 Large Samples	Al <sub>2</sub> O <sub>3</sub>	.062 Inch (1.6mm)	AM1050
Rc 30-45 Medium Hard	Al <sub>2</sub> O <sub>3</sub>	.070 Inch (1.8mm)	AM1067
Rc 25-35 Medium Soft	Al <sub>2</sub> O <sub>3</sub>	.062 Inch (1.6mm)	AM1051

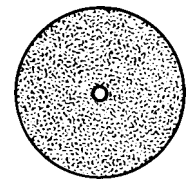

9 Inch (229 mm) with 1.25 Inch (32 mm) Arbor Hole		Wheels Sold in 10/Pkg. Only	
RECOMMENDED USE	ABRASIVE	THICKNESS	CATALOG NO.
Rc 60+ Hardened	Al <sub>2</sub> O <sub>3</sub>	.070 Inch (1.8mm)	AM1035
Rc 45-60 Hardened	Al <sub>2</sub> O <sub>3</sub>	.070 Inch (1.8mm)	AM1036
Rc 30-45 Medium Hard	Al <sub>2</sub> O <sub>3</sub>	.070 Inch (1.8mm)	AM1037
Rc 25-35 Medium Soft	Al <sub>2</sub> O <sub>3</sub>	.070 Inch (1.8mm)	AM1049
Delicate Cutting			
Ultra Thin Blade	Al <sub>2</sub> O <sub>3</sub>	.040 Inch (1.0mm)	AM0309
Hard Non-ferrous			
Rocks & Glass Etc.	SiC	.062 Inch (1.6mm)	AM1052
Zirconium, Titanium			
Uranium, etc.	SiC	.062 Inch (1.6mm)	AM1053

## MISCELLANEOUS CUTTING SUPPLIES



Coolant Concentrate - for use with cutters and grinders. Not recommended for use when cutting aluminum or brass.

Nitrite-Free Coolant Concentrate - for use when cutting aluminum, brass, and other soft materials. Will not corrode these materials.

Cutting Fluid - for use with diamond wafering blades and low speed saws.

DESCRIPTION	UNIT	CATALOG NO.
Coolant Concentrate	1 quart	AM1106
Coolant Concentrate	1 gallon	AM1107
Nitrite-Free Coolant Concentrate	1 quart	AM1108
Nitrite-Free Coolant Concentrate	1 gallon	AM1109
Cutting Fluid for Diamond Saws	1 quart	AM1023
Cutting Fluid for Diamond Saws	1 gallon	AM1024
Dressing Sticks for Diamond Saw	Each	AM1724
Dressing Sticks for Abrasive Wheels	Each	AM1725
Ultrasonic Cleaner	Each	AM0200
Ultrasonic Cleaner Sol.	1 quart	AM1110

ORDER TOLL FREE - 1-800-833-3083  
OR PHONE 269-465-5559 - FAX 269-465-3629

## ALCRON® DIAMOND COMPOUNDS



**IMPTECH D-10**  
Automatic Fluid Dispensing Unit  
ALPHA Part Number IDM001

### ALCRON® "PUMP" DIAMOND SUSPENSION

Alpha introduces another new product with very attractive features. The Alcron® Diamond Suspension ensures that the user can **utilize 100% of the contents** he is paying for. The hand pump device is **resistant to nozzle clogging**, especially in the high micron sizes. This item can be used as either a suspension or a spray. The Alcron® Suspension is sold only in "super heavy" concentrations which contains three to **four times more diamond** than most aerosol cans sold. Available in 4 oz. hand pump bottles of oil/water soluble suspension.



#### ADVANTAGES

- Faster
- No Lubrication
- Infinite Shelf Life
- Simple & Reliable
- Non-Clogging Nozzale
- Total Contents Useable
- Non-Evaporative
- Oil/Water Soluble
- Color Coded for Micron Sizes

MICRON	CONCENTRATION	COLOR	CATALOG NO.
1/4	Super Heavy	White	AM0500
1/2	Super Heavy	White	AM0501
1	Super Heavy	White	AM0502
3	Super Heavy	Yellow	AM0503
6	Super Heavy	Orange	AM0504
9	Super Heavy	Green	AM0505
15	Super Heavy	Blue	AM0506
30	Super Heavy	Red	AM0507
45	Super Heavy	Brown	AM0508

### ALCRON® DIAMOND SLURRY

The same high quality natural diamond that is available in Alpha's Alcron® Compound is now offered in a water/oil soluble slurry form. The diamond slurries are already diluted for immediate use and are more economical. The 400 g. bottle of slurry is about equivalent to 18 g. of diamond paste.



MICRON	CONCENTRATION	COLOR	CATALOG NO.
1.0 Slurry	White	400 Grams	AM1010
3.0 Slurry	Yellow	400 Grams	AM1012
6.0 Slurry	Orange	400 Grams	AM1014
10.0 Slurry	Green	400 Grams	AM1016
15.0 Slurry	Lt. Blue	400 Grams	AM1018
30.0 Slurry	Red	400 Grams	AM1020

# ALCRON® DIAMOND COMPOUNDS

ALCRON® Diamond Compounds are made from the finest bort. They are prepared, graded, compounded and guaranteed to conform to NIST Commercial Standard CS 261-61. We offer both "Heavy" and "Medium" concentrations for use with your polishing cloths. The Heavy Concentration has 20% diamond in the syringe while the Medium Concentration has 15% diamond in the syringe. We offer both 5 and 20 gram syringes in the complete range of micron sizes. All ALCRON® Diamond Compounds are both water and oil soluble. You will find additional ALCRON® supplies on the next two pages as well. Try all of these affordably priced products today.

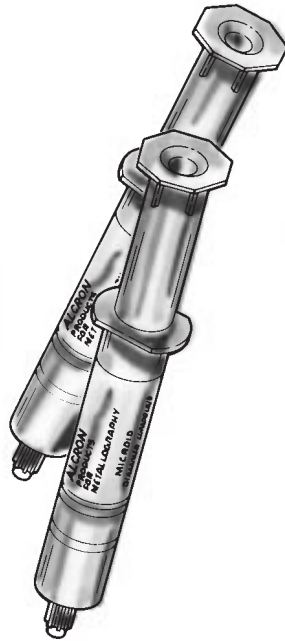

## ALCRON® DIAMOND COMPOUND

Heavy Concentration • 5 Gram and 20 Gram Syringes

MICRON	UNIT	COLOR	CATALOG NO.
45	5 Gram	Brown	AM0918
45	20 Gram	Brown	AM0919
30	5 Gram	Red	AM0916
30	20 Gram	Red	AM0917
15	5 Gram	Blue	AM0877
15	20 Gram	Blue	AM0878
10	5 Gram	Green	AM0875
10	20 Gram	Green	AM0876
6	5 Gram	Orange	AM0910
6	20 Gram	Orange	AM0911
3	5 Gram	Yellow	AM0908
3	20 Gram	Yellow	AM0909
1.25	5 Gram	White	AM0906
1.25	20 Gram	White	AM0907

## ALCRON® DIAMOND COMPOUND

Medium Concentration • 5 Gram and 20 Gram Syringes

MICRON	UNIT	COLOR	CATALOG NO.
45	5 Gram	Brown	AM0899
45	20 Gram	Brown	AM0901
30	5 Gram	Red	AM0897
30	20 Gram	Red	AM0898
15	5 Gram	Blue	AM0895
15	20 Gram	Blue	AM0896
10	5 Gram	Green	AM0893
10	20 Gram	Green	AM0894
6	5 Gram	Orange	AM0891
6	20 Gram	Orange	AM0892
3	5 Gram	Yellow	AM0889
3	20 Gram	Yellow	AM0890
1.25	5 Gram	White	AM0887
1.25	20 Gram	White	AM0888
.625	5 Gram	White	AM0867
.625	20 Gram	White	AM0868
.25	5 Gram	White	AM0865
.25	20 Gram	White	AM0866



# DIAMOND CUT-OFF SUPPLIES



The IMPTECH PC-10 is small and compact with a functional design. It has a variable speed of 0-400 rpm and an easily removed fluid tank. It is easy to operate and can accommodate diamond, silicon carbide and aluminum oxide wafering blades. It can hold up to 300 grams and can section samples up to 50 mm in width with .01 mm accuracy.

**IMPTECH PC-10**  
Precision Cut-Off Machine  
ALPHA Part Number  
PC10000

## DIAMOND CUT-OFF BLADES

### DIAMOND WAFERING BLADES

For use on Low-Speed Diamond Saws • 1/2 Inch (12.7 mm) Hole

WHEEL SIZE	THICKNESS	CATALOG NO.
5 Inch (127 mm)	.014 Inch (.35 mm)	AM1136
4 Inch (102 mm)	.012 Inch (.31 mm)	AM1137
3 Inch (76.2 mm)	.006 Inch (.16 mm)	AM1138



### MINIATURE ABRASIVE CUT-OFF WHEELS

4 Inch (101.6 mm) • 1/2 Inch (12.7 mm) Hole

DESCRIPTION	THICKNESS	CATALOG NO.
Al <sub>2</sub> O <sub>3</sub>	.015 Inch (.38 mm)	AM1146
SiC	.031 Inch (.79 mm)	AM1147



## DIAMOND GRINDING DISCS

### METAL BONDED (Electroplated)

8 Inch (203 mm) • No Hole • PSA • Full Surface Diamond

MICRON	MESH	CATALOG NO.
149-176	100	AM0396
63-74	220	AM0397
45	280	AM0398
30	320	AM0399
15		AM0401

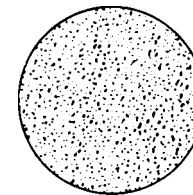

8 Inch (203 mm) • 1 Inch (25 mm) Hole • Plain Black  
2 1/2 Inch (64 mm) Safe Center Area

MICRON	MESH	CATALOG NO.
149-176	100	AM0402
63-74	220	AM0403
45	280	AM0404
30	320	AM0405
15		AM0406

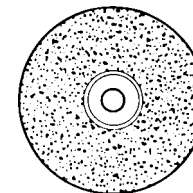



## SPECIMEN MOUNTING



**IMPTECH PA-30**  
Automatic Specimen  
Mounting Press  
ALPHA Part Number  
PA30001

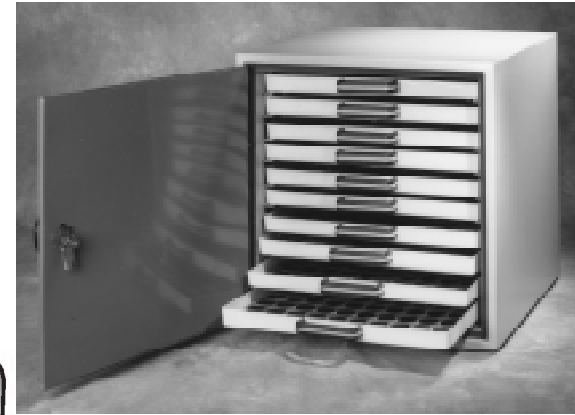

**IMPTECH D-1**  
Ten Drawer  
Specimen Cabinet  
ALPHA Part Number  
D1

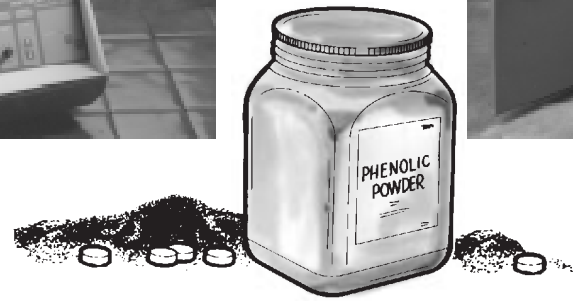

### THERMOSETTING PHENOLIC (BAKELITE®) PREFORMS

Bakelite® Preforms are a more convenient and cleaner method for mounting specimens. Since they come as solid round discs, you minimize the mess associated with the use of powders. Bakelite® Preforms are resin molds which cure at 4200 psi and 150°C. They are good for mounting materials which will not be deformed by high pressure or temperature. This method is more economical and usually requires less time.



DESCRIPTION	UNIT	CATALOG NO.
Black, 1" dia.	20	AM1300
Black, 1" dia.	100	AM1301
Black, 1" dia.	500	AM1302
Black, 1" dia.	1000	AM1303
Black, 1 1/4" dia.	20	AM1304
Black, 1 1/4" dia.	100	AM1305
Black, 1 1/4" dia.	500	AM1306
Black, 1 1/4" dia.	1000	AM1307
Black, 1 1/2" dia.	20	AM1308
Black, 1 1/2" dia.	100	AM1309
Black, 1 1/2" dia.	500	AM1310
Black, 1 1/2" dia.	1000	AM1311
Red, 1" dia.	20	AM1312
Red, 1" dia.	100	AM1313
Red, 1" dia.	500	AM1314
Red, 1" dia.	1000	AM1315
Red, 1 1/4" dia.	20	AM1316
Red, 1 1/4" dia.	100	AM1317
Red, 1 1/4" dia.	500	AM1318
Red, 1 1/4" dia.	1000	AM1319
Red, 1 1/2" dia.	20	AM1320
Red, 1 1/2" dia.	100	AM1321
Red, 1 1/2" dia.	500	AM1322
Red, 1 1/2" dia.	1000	AM1323
Green, 1" dia.	20	AM1324
Green, 1" dia.	100	AM1325
Green, 1" dia.	500	AM1326
Green, 1" dia.	1000	AM1327
Green, 1 1/4" dia.	20	AM1328
Green, 1 1/4" dia.	100	AM1329
Green, 1 1/4" dia.	500	AM1330
Green, 1 1/4" dia.	1000	AM1331
Green, 1 1/2" dia.	20	AM1332
Green, 1 1/2" dia.	100	AM1333
Green, 1 1/2" dia.	500	AM1334
Green, 1 1/2" dia.	1000	AM1335

## MICROFINISHING / POLISHING FILMS

The 3M™ Imperial™ Diamond Lapping Film offers a repeatable, precision finish on extremely hard materials. It combines micron-graded diamond particles contained in ceramic beads, a resin bonding system and a highly uniform polyester film backing for a cleaner more consistent alternative to diamond compounds or slurries. These features allow the 3M™ Imperial™ Diamond Lapping Film to be more aggressive than the average product. Grade for grade, this product will yield more cut and a longer life. This product is recommended for extremely hard materials and larger parts. Examples of this include carbides, ceramics, high hardness metals, rocks and minerals, fiber optic connectors, magnetic heads, metallurgical testing and other lapping and polishing applications. The 3M™ Imperial™ Diamond Lapping Film is sold in packages of five sheets. They are PSA backed for easier use and are 3 mil. in thickness. To start using these new products immediately, please call ALPHA RESOURCES toll free today at 1-800-833-3083.

### IMPERIAL™ • DIAMOND MICRON LAPPING FILM

8 Inch • PSA Backed • No Hole • Wet or Dry

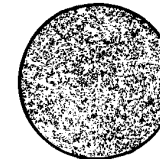

8 Inch  
PSA Back  
No Hole

DESCRIPTION	UNIT	CATALOG NO.
Diamond Lapping Film, 8"xNH, PSA back, 30 micron	5/box	AM1801
Diamond Lapping Film, 8"xNH, PSA back, 15 micron	5/box	AM1802
Diamond Lapping Film, 8"xNH, PSA back, 9 micron	5/box	AM1803
Diamond Lapping Film, 8"xNH, PSA back, 6 micron	5/box	AM1804
Diamond Lapping Film, 8"xNH, PSA back, 3 micron	5/box	AM1805
Diamond Lapping Film, 8"xNH, PSA back, 1 micron	5/box	AM1806
Diamond Lapping Film, 8"xNH, PSA back, .5 micron	5/box	AM1807

### IMPERIAL™ • DIAMOND MICRON LAPPING FILM

12 Inch • PSA Backed • No Hole • Wet or Dry

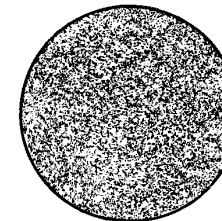

12 Inch  
PSA Back  
No Hole

DESCRIPTION	UNIT	CATALOG NO.
Diamond Lapping Film, 12"xNH, PSA back, 30 micron	3/box	AM1811
Diamond Lapping Film, 12"xNH, PSA back, 15 micron	3/box	AM1812
Diamond Lapping Film, 12"xNH, PSA back, 9 micron	3/box	AM1813
Diamond Lapping Film, 12"xNH, PSA back, 6 micron	3/box	AM1814
Diamond Lapping Film, 12"xNH, PSA back, 3 micron	3/box	AM1815
Diamond Lapping Film, 12"xNH, PSA back, 1 micron	3/box	AM1816
Diamond Lapping Film, 12"xNH, PSA back, .5 micron	3/box	AM1817



The 3M™ Imperial™ Aluminum Oxide Microfinishing Film offers final polishing for use with a wide variety of materials including metal, plastic, fiberglass, solid-surface composites and other materials. The product is a fast cutting abrasive that provides a precise, uniform, close-tolerance finish. The material has a high-strength polyester film backing and coated with premium, micron-graded mineral particles that are electrostatically oriented for greater cutting efficiency. They are resin bonded for increased durability. This material has the PSA backing for easy to use non-slip performance and is 3 mil. in thickness.

### IMPERIAL™ • ALUMINUM OXIDE MICROFINISHING FILM

8 Inch • PSA Back • No Hole

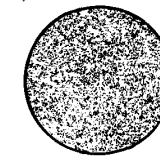

8 Inch  
PSA Back  
No Hole

DESCRIPTION	UNIT	CATALOG NO.
Al <sub>2</sub> O <sub>3</sub> Microfinishing Film, 8"xNH, PSA Back, 1 micron	100	AM1500
Al <sub>2</sub> O <sub>3</sub> Microfinishing Film, 8"xNH, PSA Back, 3 micron	100	AM1501
Al <sub>2</sub> O <sub>3</sub> Microfinishing Film, 8"xNH, PSA Back, 6 micron	100	AM1502
Al <sub>2</sub> O <sub>3</sub> Microfinishing Film, 8"xNH, PSA Back, 9 micron	100	AM1503
Al <sub>2</sub> O <sub>3</sub> Microfinishing Film, 8"xNH, PSA Back, 15 micron	100	AM1504

### IMPERIAL™ • ALUMINUM OXIDE MICROFINISHING FILM

12 Inch • PSA Back • No Hole

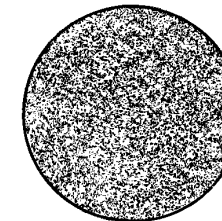

12 Inch  
PSA Back  
No Hole

DESCRIPTION	UNIT	CATALOG NO.
Al <sub>2</sub> O <sub>3</sub> Microfinishing Film, 12"xNH, PSA Back, 1 micron	100	AM1510
Al <sub>2</sub> O <sub>3</sub> Microfinishing Film, 12"xNH, PSA Back, 3 micron	100	AM1511
Al <sub>2</sub> O <sub>3</sub> Microfinishing Film, 12"xNH, PSA Back, 6 micron	100	AM1512
Al <sub>2</sub> O <sub>3</sub> Microfinishing Film, 12"xNH, PSA Back, 9 micron	100	AM1513
Al <sub>2</sub> O <sub>3</sub> Microfinishing Film, 12"xNH, PSA Back, 15 micron	100	AM1514

## POLISHING CLOTHS

### NAPLESS

DESCRIPTION WHEEL SIZE	RECOMMENDED USE	UNIT	CATALOG NO.
Nylon, 2 7/8" PSA	rough polishing of most materials with diamond compound	10/pkg.	AM7052
Nylon, for 8" Plain back		10/pkg.	AM0462
Nylon, 8" PSA		10/pkg.	AM0463
Nylon, 8"x2 1/2" PSA		10/pkg.	AM0464
Nylon, for 12" Plain back		10/pkg.	AM0511
Nylon, 12" PSA		10/pkg.	AM0451
Nylon, 12"x2 1/2" PSA		10/pkg.	AM0452
Nylon, 14" Plain back		10/pkg.	AM0332
Nylon, 14" PSA		10/pkg.	AM0333
Canvas, for 8" Plain back	general very rough polishing using course grades of ALOX or SiC powders	10/pkg.	AM0469
Canvas, for 12" Plain back		10/pkg.	AM0518
Canvas, for 12" PSA		10/pkg.	AM0519
Cotton, for 8" Plain Back	rough polishing of softer materials with diamond, also with alumnas & suspensions	10/pkg.	AM0471
Cotton, for 12" Plain Back		10/pkg.	AM0512
Silk, for 8" Plain Back	slurry or skid polishing; preliminary rough polishing with ALOX; also rough polishing of metals with diamond	10/pkg.	AM0472
Silk, for 12" Plain Back		10/pkg.	AM0516
Silk, for 14" Plain Back		10/pkg.	AM0517
Pan W, 2 7/8" PSA	oil/water resistant; rough polishing of steel gives good edge retention	10/pkg.	AM7602
Pan W, 8" PSA		10/pkg.	AM0482
Pan W, 8"x2 1/2" PSA		10/pkg.	AM0495
Pan W, 12" PSA		10/pkg.	AM0529
Pan W, 12"x2 1/2" PSA		10/pkg.	AM0542
Pan W, 14" PSA		10/pkg.	AM0316

### NAPPED

Alpha Cloth, for 2 7/8" PSA	final polishing with diamond compounds & alumnas	10/pkg.	AM7212	
Alpha Cloth, for 6.5" PSA		10/pkg.	AM0496	
Alpha Cloth, for 8" Plain Back		10/pkg.	AM0549	
Alpha Cloth, 8" PSA		10/pkg.	AM0497	
Alpha Cloth, 8"x2 1/2" PSA		10/pkg.	AM0538	
Alpha Cloth, for 12" Plain Back		10/pkg.	AM0539	
Alpha Cloth, 12" PSA		10/pkg.	AM0540	
Alpha Cloth, 12"x2 1/2" PSA		10/pkg.	AM0541	
Alpha Cloth, 14" Plain Back		10/pkg.	AM0334	
Alpha Cloth, 14" PSA		10/pkg.	AM0327	
Red Felt, for 8" Plain Back		general rough polishing of steels and other ferrous based materials with aluminum oxide	10/pkg.	AM0466
Red Felt, for 8" PSA			10/pkg.	AM0647
Red Felt, for 8" x 2 1/2" PSA	10/pkg.		AM0648	
Red Felt, for 10" Plain Back	10/pkg.		AM0459	
Red Felt, for 12" Plain Back	10/pkg.		AM0460	
Red Felt, for 12" PSA	10/pkg.		AM0644	
Red Felt, for 14" Plain Back	10/pkg.		AM0467	
Red Felt, for 14" PSA	10/pkg.		AM0328	
Billiard Cloth, for 8" Plain Back	10/pkg.		AM0465	
Billiard Cloth, for 12" Plain Back	10/pkg.	AM0514		
Billiard Cloth, for 14" Plain Back	10/pkg.	AM0515		
Kitten's Ear, for 8" Plain Back	short pile, for general purpose final polishing; use with fine Al <sub>2</sub> O <sub>3</sub>	10/pkg.	AM0550	
Kitten's Ear, for 10" Plain Back		10/pkg.	AM0551	
Kitten's Ear, for 12" Plain Back		10/pkg.	AM0552	
Kitten's Ear, for 14" Plain Back		10/pkg.	AM0553	
Kitten's Ear, for 8" PSA		10/pkg.	AM0554	
Velvet, for 8" Plain Back	final polishing of soft metals & crystals	10/pkg.	AM0468	
Selvyt, for 8" Plain Back	med. nap; rough & final polishing of metals & ceramics	10/pkg.	AM0461	
Selvyt, for 12" Plain Back		10/pkg.	AM0510	
Imperial Cloth, for 8" PSA	final polish of metals ceramics, IC & PC sections	10/pkg.	AM0445	
Imperial Cloth, for 12" PSA		10/pkg.	AM0446	
Imperial Cloth, for 14" PSA		10/pkg.	AM0447	

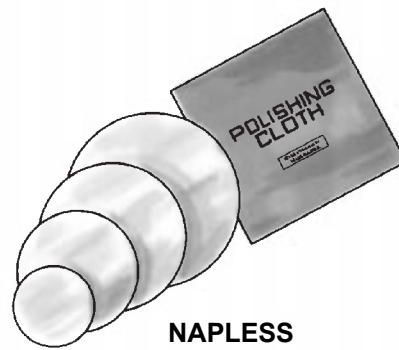

NAPLESS

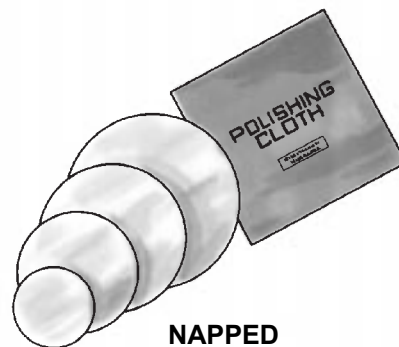

NAPPED

## SPECIMEN MOUNTING

### COMPRESSION MOLDING POWDERS

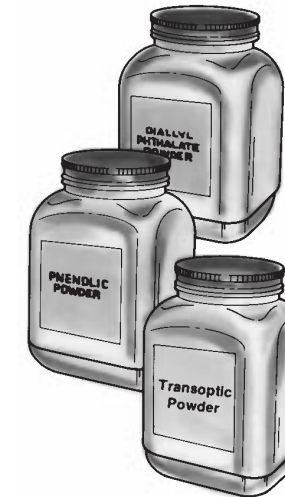

DESCRIPTION	RECOMMENDED MOLDING PRESSURE	UNIT	CATALOG NO.
Black Phenolic	4200 PSI	5 lb.	AM1111
Red Phenolic	4200 PSI	5 lb.	AM1118
Green Phenolic	4200 PSI	5 lb.	AM1123
Blue Diallyl Phthalate, mineral filled	3000 PSI	5 lb.	AM1135
Blue Diallyl Phthalate, glass filled	3000 PSI	5 lb.	AM1142
Diallyl Phthalate, copper filled	3000 PSI	1 lb. 5 lb.	AM1143 AM1139
Transparent Lucite®	100 PSI/4200 PSI	5 lb.	AM1133
Fina-met	3000-4200 PSI	4 lb.	AM1144



IMPTECH M-10  
Hydraulic Specimen Mounting Press  
ALPHA Part Number M10001

### COMPRESSION MOLDING

This sample preparation method has long been used to help protect the sample edge during the various stages of preparation. Cost is minimal and samples can be processed in a few minutes.

	THERMOSETTING MATERIAL
Phenolics:	Poor edge retention, high shrinkage, available in many colors
Diallyls:	Fair edge retention, moderate shrinkage, available in many forms
Fina-met:	Excellent edge retention, glass filled ground Bakelite® powder
	THERMOPLASTIC MATERIAL
Acrylics:	Fair edge retention, moderate shrinkage, transparent

### MOLD CUPS

Reusable Silicone Rubber Molds-All Dimensions Inside Diameter

SIZE	UNIT	CATALOG NO.
1.00 Inch (2.5 cm)	Each	AM3018
1.25 Inch (3.2 cm)	Each	AM3019
1.50 Inch (3.8 cm)	Each	AM3020

### MISCELLANEOUS MOUNTING SUPPLIES

PRODUCT	UNIT	CATALOG NO.
Plastic Sample Clips	100	AM0486
Metal Spring Clips	100	AM0485
Silicone Aerosol Mold Release	20 oz.	*AM1271
Graduated Paper Cups, 5 oz.	100	AM1275
Ultra Sonic Cleaner (see pg.6)	Each	AM0200
Stirring Sticks	500	AM0995
Cotton Gloves	Pr.	AM0635
Leather Gloves	Pr.	AM0636

\*Hazardous Material





# COLD MOUNTING MATERIALS

## COLD MOUNTING MATERIALS

These materials are recommended for mounting specimens easily deformed by heat and pressure. Cold mounting is ideal for use when you want to observe the orientation of the specimen. It is also good when you want to mount small fragile specimens. In this system of mounting, edge protection is also of paramount importance.

**Acrylics:** Poor edge retention, high exotherm, high shrinkage, transparent  
**Epoxy:** Good edge retention, low exotherm, low shrinkage, transparent

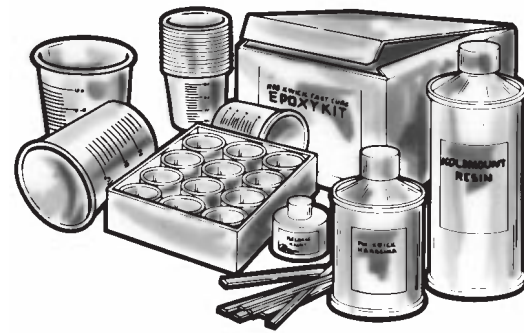

## ACRYLICS

**Exothermal Temperature Rise:** High  
**Relative Hardness:** Medium  
**Color:** Milky White

**Shrinkage:** High  
**Adhesion:** Fair

**Acrylic Mixing Instructions:** (AM1201-AM1209): The recommended ratio is two parts resin to one part hardener by volume. Mix for 30 seconds and pour over specimen. Cure time is about 30 minutes at room temperature.

DESCRIPTION	CURE TIME	UNIT	CATALOG NO.
Koldmount Acrylic Kit	20-30 min. at room temp.	1 lb. Resin/ 12 oz. Hardener	* AM1201
Koldmount Liquid		12 oz. hardener	* AM1203
Koldmount Powder		1 oz. Redsin	AM1202
Koldmount Acrylic Kit		5 lb. Resin/ 60 oz. Hardener	* AM1204
Koldmount Liquid		60 oz. Hardener	* AM1205
Koldmount Powder		5 lb. Resin	AM1206
Quickmount Acrylic Kit	30 min. at room temp.	2 lb. Resin/ 24 oz. Hardener	* AM1207
Quickmount Liquid		24 oz. Hardener	* AM1208
Quickmount Powder		2 lb. Resin	AM1209

\* Hazardous Materials

## EPOXY

**Exothermal Temperature Rise:** Low  
**Relative Hardness:** Very Hard  
**Color:** Transparent White  
**Shrinkage:** Low  
**Adhesion:** Very Good

**Epoxy Mixing Instructions:** (AM1161-AM1166): The recommended ratio is 100 grams of resin to 13 grams of hardener. Cure time is about 12 hours in air or 6 hours in oven at 80 Celsius.  
 (AM1167-AM1170) the recommended ratio is 2 parts resin to 1 part hardener by volume. Cure time is about one hour at room temperature.

DESCRIPTION	CURE TIME	UNIT	CATALOG NO.
Epoxy Kit	Air 12 hrs. Oven 6 hrs.	1 qt. Resin/ 8 oz. Hardener	* AM1161
Epoxy Kit	Air 12 hrs. Oven 6 hrs.	1 gal. Resin/ 1 qt. hardener	* AM1162
Epoxy Resin		1 qt.	AM1163
Epoxy Resin		1 gal.	AM1164
Epoxy Hardener		8 oz.	* AM1165
Epoxy Hardener		1 qt.	* AM1166
Fast Set Epoxy Resin	1 hr.	1 qt.	AM1167
Fast Set Epoxy Hardener	1 hr.	8 oz.	* AM1168
Fast Set Epoxy Resin	1 hr.	1 gal.	AM1169
Fast Set Epoxy Hardener	1 hr.	1 qt.	* AM1170

\* Hazardous Materials

# ABRASIVE DISCS

## ALUMINUM OXIDE • WET OR DRY • PSA BACK

8 Inch (203 mm) • No Hole

DESCRIPTION	UNIT	CATALOG NO.
Al <sub>2</sub> O <sub>3</sub> Discs, 8"xNH, PSA back, grit 60	25/box	AM2034
Al <sub>2</sub> O <sub>3</sub> Discs, 8"xNH, PSA back, grit 80	25/box	AM2032
Al <sub>2</sub> O <sub>3</sub> Discs, 8"xNH, PSA back, grit 120	25/box	AM2035
Al <sub>2</sub> O <sub>3</sub> Discs, 8"xNH, PSA back, grit 180	25/box	AM2036
Al <sub>2</sub> O <sub>3</sub> Discs, 8"xNH, PSA back, grit 240	25/box	AM20330

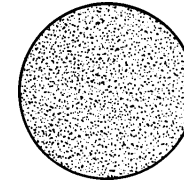

8 Inch (203 mm)  
NH - No Hole - PSA Back

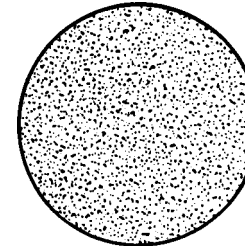

12 Inch (305 mm)  
No Hole - PSA Back

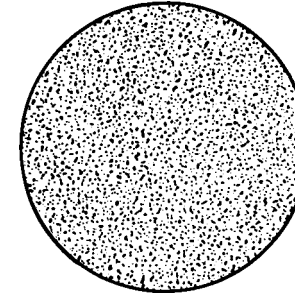

14 Inch (356 mm)  
No Hole - PSA Back

## ALUMINUM OXIDE • WET OR DRY • PSA BACK

12 Inch (305 mm) • No Hole

DESCRIPTION	UNIT	CATALOG NO.
Al <sub>2</sub> O <sub>3</sub> Discs, 12"xNH, PSA back, grit 60	25/box	AM2082
Al <sub>2</sub> O <sub>3</sub> Discs, 12"xNH, PSA back, grit 120	25/box	AM2083
Al <sub>2</sub> O <sub>3</sub> Discs, 12"xNH, PSA back, grit 180	25/box	AM2084

## ALUMINUM OXIDE • WET OR DRY • PSA BACK

14 Inch (356 mm) • No Hole

DESCRIPTION	UNIT	CATALOG NO.
Al <sub>2</sub> O <sub>3</sub> Discs, 14"xNH, PSA back, grit 60	25/box	AM2085
Al <sub>2</sub> O <sub>3</sub> Discs, 14"xNH, PSA back, grit 120	25/box	AM2086
Al <sub>2</sub> O <sub>3</sub> Discs, 14"xNH, PSA back, grit 180	25/box	AM2087

## GRIT COMPARISON CHART

GRIT SIZE U.S.A.	GRIT SIZE EUROPE	ANSI MICRONS	FEPA "P" MICRONS
60	60	250	250
80	80	180	180
100	100	150	150
120	120	106	106
150	150	90	90
180	180	75	75
220	220	63	63
240	240	51.8	58.5
	280	42.3	52.2
280	320	34.3	46.2
320	360	27.3	40.5
	400	22.1	35.0
360	500	18.2	30.2
400	600	14.5	25.8
	800	10.2	21.8
500	1000		18.3
600	1200		15.3
	1500		12.6
	2000		10.3
800	2400		
	2500		8.4
	3000		4.0
1200	4000		3.0

## ABRASIVE DISCS

### SILICON CARBIDE • WET OR DRY • PSA BACK

14 Inch (356 mm) Diameter • No Hole • C Weight

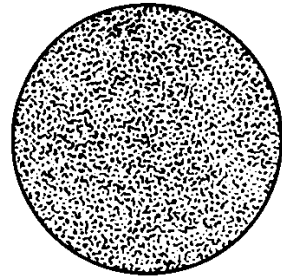

14 Inch (356 mm)  
PSA Back  
No Hole

DESCRIPTION	UNIT	CATALOG NO.
SiC Discs, 14"xNH, PSA back, grit 60	100/box	AM0424
SiC Discs, 14"xNH, PSA back, grit 120	100/box	AM0425
SiC Discs, 14"xNH, PSA back, grit 180	100/box	AM0426
SiC Discs, 14"xNH, PSA back, grit 240	100/box	AM0427
SiC Discs, 14"xNH, PSA back, grit 320	100/box	AM0428
SiC Discs, 14"xNH, PSA back, grit 400	100/box	AM0429
SiC Discs, 14"xNH, PSA back, grit 600	100/box	AM0430
SiC Discs, 14"xNH, PSA back, grit 800	100/box	AM0885
SiC Discs, 14"xNH, PSA back, grit 1200	100/box	AM0886

Zirconia Alumina abrasive cloths may be used for wet or dry grinding. They have a fast cutting rate and they operate cooler than SiC abrasives. The ZIR AL abrasive cloths have a longer life and are more durable than SiC and other abrasive papers. Please note the package quantities are different from the standard SiC packaging.

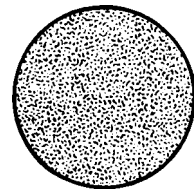

8 Inch (203 mm)  
No Hole - PSA Back  
No Hole - Plain Back

### ZIRCONIA ALUMINA • WET OR DRY CLOTH

8 Inch (203 mm) • No Hole • Plain Back

DESCRIPTION	UNIT	CATALOG NO.
ZIR AL Discs, 8"xNH, Plain back, grit 60	25/box	AM0341 PB
ZIR AL Discs, 8"xNH, Plain back, grit 120	25/box	AM0342 PB
ZIR AL Discs, 8"xNH, Plain back, grit 180	25/box	AM0343 PB
ZIR AL Discs, 8"xNH, Plain back, grit 220	25/box	AM0344 PB

### ZIRCONIA ALUMINA • WET OR DRY CLOTH

8 Inch (203 mm) • No Hole • PSA Back

DESCRIPTION	UNIT	CATALOG NO.
ZIR AL Discs, 8"xNH, PSA back, grit 60	25/box	AM0341
ZIR AL Discs, 8"xNH, PSA back, grit 120	25/box	AM0342
ZIR AL Discs, 8"xNH, PSA back, grit 180	25/box	AM0343
ZIR AL Discs, 8"xNH, PSA back, grit 220	25/box	AM0344

### ZIRCONIA ALUMINA • WET OR DRY CLOTH

12 Inch (305 mm) • No Hole • PSA Back

DESCRIPTION	UNIT	CATALOG NO.
ZIR AL Discs, 12"xNH, PSA back, grit 60	25/box	AM0357
ZIR AL Discs, 12"xNH, PSA back, grit 120	25/box	AM0358

### ZIRCONIA ALUMINA • WET OR DRY CLOTH

14 Inch (356 mm) • No Hole • PSA Back

DESCRIPTION	UNIT	CATALOG NO.
ZIR AL Discs, 14"xNH, PSA back, grit 60	25/box	AM2080
ZIR AL Discs, 14"xNH, PSA back, grit 120	25/box	AM2081

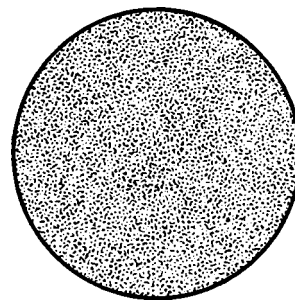

12 Inch (305 mm)  
No Hole - PSA Back

14 Inch (356 mm)  
No Hole - PSA Back

## ABRASIVE BELTS AND ROLLS

### SILICON CARBIDE BELTS • WET OR DRY

DESCRIPTION	UNIT	CATALOG NO.
SiC Belts, 4"x36", grit 50	10/box	AM0001
SiC Belts, 4"x36", grit 80	10/box	AM0002
SiC Belts, 4"x36", grit 100	10/box	AM0009
SiC Belts, 4"x36", grit 120	10/box	AM0003
SiC Belts, 4"x36", grit 180	10/box	AM0004
SiC Belts, 4"x36", grit 240	10/box	AM0005
SiC Belts, 4"x36", grit 320	10/box	AM0006
SiC Belts, 4"x36", grit 400	10/box	AM0007
SiC Belts, 4"x36", grit 600	10/box	AM0008

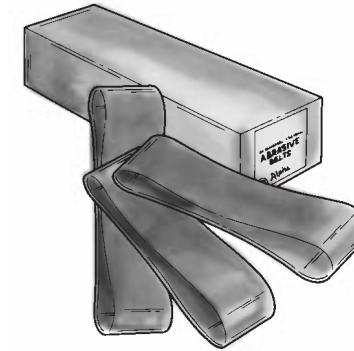

ALL BELTS FEATURE THE  
"SEAMLESS  
METALLURGICAL SPLICE"

### ZIR AL BELTS • WET OR DRY

Zirconia Alumina abrasive belts may be used for wet or dry grinding. They have a fast cutting rate and they operate cooler than SiC abrasives. The ZIR AL abrasive belts also have a longer life than SiC. Please note the package quantities are different from the standard SiC packaging.

DESCRIPTION	UNIT	CATALOG NO.
ZIR AL Belts, 4"x36", grit 50	5/box	AM0544
ZIR AL Belts, 4"x36", grit 60	5/box	AM0545
ZIR AL Belts, 4"x36", grit 120	5/box	AM0546
ZIR AL Belts, 4"x36", grit 180	5/box	AM0547
ZIR AL Belts, 4"x36", grit 220	5/box	AM0548

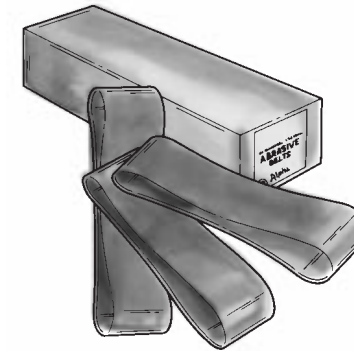

### ALUMINUM OXIDE BELTS • WET OR DRY

DESCRIPTION	UNIT	CATALOG NO.
Al <sub>2</sub> O <sub>3</sub> Belts, 4"x36", grit 50	10/box	AM0021
Al <sub>2</sub> O <sub>3</sub> Belts, 4"x36", grit 60	10/box	AM0020
Al <sub>2</sub> O <sub>3</sub> Belts, 4"x36", grit 80	10/box	AM0022
Al <sub>2</sub> O <sub>3</sub> Belts, 4"x36", grit 120	10/box	AM0023
Al <sub>2</sub> O <sub>3</sub> Belts, 4"x36", grit 180	10/box	AM0024
Al <sub>2</sub> O <sub>3</sub> Belts, 4"x36", grit 240	10/box	AM0025

### ALUMINUM OXIDE BELTS • DRY ONLY

DESCRIPTION	UNIT	CATALOG NO.
Al <sub>2</sub> O <sub>3</sub> Belts, 4"x36", grit 50	10/box	AM0436
Al <sub>2</sub> O <sub>3</sub> Belts, 4"x36", grit 80	10/box	AM0437
Al <sub>2</sub> O <sub>3</sub> Belts, 4"x36", grit 120	10/box	AM0438

### SILICON CARBIDE ROLLS • WET OR DRY

3 Inch (76 mm) x 75 Ft. (23 m) • C Weight

DESCRIPTION	UNIT	CATALOG NO.
SiC 3"x75 ft., grit 60	Roll	AM0085
SiC 3"x75 ft., grit 120	Roll	AM0086
SiC 3"x75 ft., grit 180	Roll	AM0087
SiC 3"x75 ft., grit 240	Roll	AM0088
SiC 3"x75 ft., grit 320	Roll	AM0089
SiC 3"x75 ft., grit 400	Roll	AM0090
SiC 3"x75 ft., grit 600	Roll	AM0091





# CROSS REFERENCE

ALPHA	BUEHLER®	LECO®	ALPHA	BUEHLER®	LECO®	ALPHA	BUEHLER®	LECO®
AM0001	16-5200	810-001	AM0332		810-332	AM0545	16-5400	810-487
AM0002	16-5200	810-002	AM0333	40-7074	810-330	AM0546	16-5400	810-499
AM0003	16-5200	810-003	AM0334		810-334	AM0547	16-5400	810-489
AM0004	16-5200	810-004	AM0341		812-021	AM0548	16-5400	810-493
AM0005	16-5200	810-005	AM0341 PB			AM0549	40-7208	810-470
AM0006	16-5200	810-006	AM0342		812-024	AM0550		
AM0007	16-5200	810-007	AM0342 PB			AM0551		
AM0008		810-008	AM0343			AM0552		
AM0009			AM0343 PB			AM0553		
AM0020		810-020	AM0344			AM0554		
AM0021		810-021	AM0344 PB			AM0635	20-3040	800-635
AM0022		810-022	AM0351			AM0644		810-644
AM0023		810-023	AM0352			AM0647		810-647
AM0024		810-024	AM0357	15-5132	812-045	AM0648		
AM0025		810-025	AM0358	15-5132	812-046	AM0665	40-6365	810-665
AM0033	30-5528	810-033	AM0396	40-4649	810-396	AM0701		
AM0034	30-5528	810-034	AM0397	40-4659	810-397	AM0702		
AM0035	30-5528	810-035	AM0398	40-4669	810-398	AM0703		
AM0036	30-5528	810-036	AM0399	40-4679	810-399	AM0704		
AM0085		810-085	AM0401	40-4689	810-401	AM0705		
AM0086		810-086	AM0402	60-4548	810-402	AM0706		
AM0087		810-087	AM0403	60-4558	810-403	AM0707		
AM0088	30-5243	810-088	AM0404	60-4568	810-404	AM0708		
AM0089	30-5243	810-089	AM0405	60-4578	810-405	AM0709		
AM0090	30-5243	810-090	AM0406	60-4588	810-406	AM0713		
AM0091	30-5243	810-091	AM0424	30-5114		AM0717		
AM0160			AM0425	30-5114	810-446	AM0719		
AM0161	30-5160	810-161	AM0426	30-5114	810-425	AM0721		
AM0162	30-5160	810-162	AM0427	30-5114	810-426	AM0722		
AM0163	30-5160	810-163	AM0428	30-5114	810-427	AM0723		
AM0164	30-5160	810-164	AM0429	30-5114	810-428	AM0724		
AM0166			AM0430	30-5114	810-429	AM0725		
AM0167			AM0436		810-430	AM0726		
AM0168			AM0437		810-437	AM0727		
AM0169			AM0438			AM0728		
AM0200			AM0445		810-545	AM0729		
AM0217	30-5108	810-217	AM0446		810-546	AM0730		
AM0218			AM0447		810-547	AM0731		
AM0219	30-5108	810-219	AM0451	40-7072	810-645	AM0732		
AM0221	30-5108	810-221	AM0452			AM0778	40-6325	810-778
AM0223	30-5108	810-223	AM0459			AM0779	40-6325	810-779
AM0225	30-5108	810-225	AM0460		810-515	AM0782	40-6323	810-782
AM0227	30-5108	810-227	AM0461	40-7008	810-461	AM0783	40-6323	810-783
AM0229	30-5108	810-229	AM0462	40-7058	810-462	AM0786	40-6321	810-786
AM0231		810-231	AM0463	40-7068	810-648	AM0787	40-6321	810-787
AM0232			AM0464	40-7078		AM0788		810-788
AM0233	30-5138	810-233	AM0465	40-7308	810-465	AM0818	40-6361	810-818
AM0235	30-5138	810-235	AM0466		810-466	AM0825	40-6360	810-825
AM0237	30-5138	810-237	AM0467		810-315	AM0825G	40-6360	810-825
AM0239	30-5138	810-239	AM0468		810-461	AM0826	40-6365	810-826
AM0241	30-5138	810-241	AM0469		810-469	AM0827	40-6363	810-827
AM0242			AM0471		810-463	AM0828		810-828
AM0243	30-5138	810-243	AM0472	40-7408	810-467	AM0829		810-829
AM0244			AM0482		810-482	AM0830		810-830
AM0245	15-5112	810-245	AM0485	20-4000	810-485	AM0831		810-831
AM0247	15-5112	810-247	AM0486	20-4100	810-815	AM0832	40-6361	810-819
AM0249	15-5112	810-249	AM0495		810-495	AM0833		
AM0251	15-5112	810-251	AM0496		810-491	AM0834	40-6363	810-832
AM0253	15-5112	810-253	AM0497	40-7218	810-497	AM0835		
AM0255	15-5112	810-255	AM0500	40-6629	810-945	AM0858	30-5532	810-858
AM0256	15-5112	810-257	AM0501			AM0859	30-5532	810-859
AM0257			AM0502	40-6630	810-944	AM0865	40-6241	810-865
AM0258			AM0503	40-6631	810-943	AM0866	40-6240	810-866
AM0259	30-5118	810-259	AM0504	40-6632	810-942	AM0867		810-867
AM0261	30-5118	810-261	AM0505	40-6633	810-941	AM0868		810-868
AM0263	30-5118	810-263	AM0506	40-6634	810-940	AM0875	40-6192	
AM0265	30-5118	810-265	AM0507	40-6635	810-939	AM0876	40-6182	
AM0267	30-5118	810-267	AM0508	40-6636	810-938	AM0877	40-6212	
AM0269	30-5118	810-269	AM0510		810-510	AM0878	40-6202	
AM0270			AM0511	40-7062	810-511	AM0885		810-885
AM0271	30-5148	810-271	AM0512		810-512	AM0886		810-886
AM0273	30-5148	810-273	AM0514	40-7132	810-514	AM0887	40-6244	810-869
AM0275	30-5148	810-275	AM0515			AM0888	40-6243	810-870
AM0277	30-5148	810-277	AM0516		810-516	AM0889	40-6247	810-871
AM0279	30-5148	810-279	AM0517		810-333	AM0890	40-6246	810-872
AM0281	30-5148	810-281	AM0518		810-518	AM0891	40-6250	810-873
AM0283			AM0519			AM0892	40-6249	810-874
AM0284			AM0529		810-529	AM0893	40-6453	810-912
AM0309	10-4127		AM0538	40-7228	810-498	AM0894	40-6252	810-913
AM0311			AM0539	40-7242	810-520	AM0895	40-6255	810-914
AM0316		810-316	AM0540	40-7222	810-543	AM0896		810-915
AM0317			AM0541			AM0897		
AM0327	40-7224	810-327	AM0542			AM0898	40-6258	810-880
AM0328		810-328	AM0544			AM0899		810-881

# ABRASIVE DISCS

## SILICON CARBIDE • WET OR DRY • PSA BACK

10 Inch (254 mm) • No Hole • C Weight

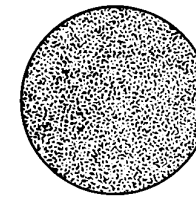

10 Inch (254 mm)  
No Hole

DESCRIPTION	UNIT	CATALOG NO.
SiC Discs, 10"xNH, PSA back, grit 60	100/box	AM2090
SiC Discs, 10"xNH, PSA back, grit 80	100/box	AM2099
SiC Discs, 10"xNH, PSA back, grit 120	100/box	AM2091
SiC Discs, 10"xNH, PSA back, grit 180	100/box	AM2092
SiC Discs, 10"xNH, PSA back, grit 240	100/box	AM2093
SiC Discs, 10"xNH, PSA back, grit 320	100/box	AM2094
SiC Discs, 10"xNH, PSA back, grit 400	100/box	AM2095
SiC Discs, 10"xNH, PSA back, grit 600	100/box	AM2096
SiC Discs, 10"xNH, PSA back, grit 800	100/box	AM2097
SiC Discs, 10"xNH, PSA back, grit 1200	100/box	AM2098

## SILICON CARBIDE • WET OR DRY • PLAIN BACK

12 Inch (305 mm) • No Hole • C Weight

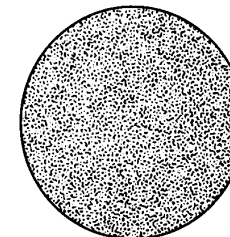

12 Inch (305 mm)  
Plain Back  
No Hole

DESCRIPTION	UNIT	CATALOG NO.
SiC Discs, 12"xNH, plain back, grit 60	100/box	AM2100
SiC Discs, 12"xNH, plain back, grit 80	100/box	AM2101
SiC Discs, 12"xNH, plain back, grit 120	100/box	AM2102
SiC Discs, 12"xNH, plain back, grit 180	100/box	AM2103
SiC Discs, 12"xNH, plain back, grit 240	100/box	AM2104
SiC Discs, 12"xNH, plain back, grit 320	100/box	AM2105
SiC Discs, 12"xNH, plain back, grit 400	100/box	AM2106
SiC Discs, 12"xNH, plain back, grit 600	100/box	AM2107
SiC Discs, 12"xNH, plain back, grit 800	100/box	AM2108
SiC Discs, 12"xNH, plain back, grit 1200	100/box	AM2109

## SILICON CARBIDE • WET OR DRY • PSA BACK

12 Inch (305 mm) Diameter • No Hole • C Weight

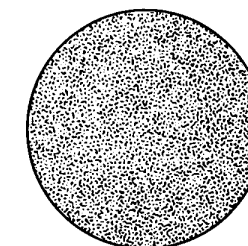

12 Inch (305 mm)  
PSA Back  
No Hole

DESCRIPTION	UNIT	CATALOG NO.
SiC Discs, 12"xNH, PSA back, grit 60	100/box	AM0245
SiC Discs, 12"xNH, PSA back, grit 120	100/box	AM0247
SiC Discs, 12"xNH, PSA back, grit 180	100/box	AM0249
SiC Discs, 12"xNH, PSA back, grit 240	100/box	AM0251
SiC Discs, 12"xNH, PSA back, grit 320	100/box	AM0253
SiC Discs, 12"xNH, PSA back, grit 400	100/box	AM0255
SiC Discs, 12"xNH, PSA back, grit 600	100/box	AM0256
SiC Discs, 12"xNH, PSA back, grit 800	100/box	AM0858
SiC Discs, 12"xNH, PSA back, grit 1200	100/box	AM0859

ORDER TOLL FREE - 1-800-833-3083  
OR PHONE 269-465-5559 - FAX 269-465-3629  
ALPHA APPRECIATES YOUR BUSINESS

# ABRASIVE DISCS

## SILICON CARBIDE • WET OR DRY • PSA BACK

8 Inch (203 mm) • No Hole • C Weight

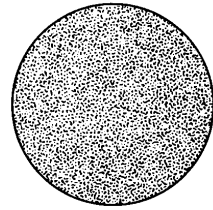

8 Inch (203 mm)  
PSA Back  
No Hole

DESCRIPTION	UNIT	CATALOG NO.
SiC Discs, 8"xNH, PSA back, grit 60	100/box	AM0257
SiC Discs, 8"xNH, PSA back, grit 80	100/box	AM0258
SiC Discs, 8"xNH, PSA back, grit 120	100/box	AM0259
SiC Discs, 8"xNH, PSA back, grit 180	100/box	AM0261
SiC Discs, 8"xNH, PSA back, grit 240	100/box	AM0263
SiC Discs, 8"xNH, PSA back, grit 320	100/box	AM0265
SiC Discs, 8"xNH, PSA back, grit 400	100/box	AM0267
SiC Discs, 8"xNH, PSA back, grit 600	100/box	AM0269
SiC Discs, 8"xNH, PSA back, grit 800	100/box	AM0033
SiC Discs, 8"xNH, PSA back, grit 1200	100/box	AM0034

## SILICON CARBIDE • WET OR DRY • PSA BACK

8 Inch (203 mm) x 2 1/2 Inch (64 mm) Hole • C Weight

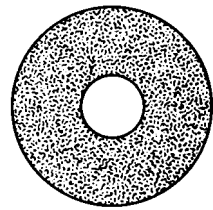

8 Inch (203 mm)  
2 1/2 Inch (64 mm) Hole  
PSA Back

DESCRIPTION	UNIT	CATALOG NO.
SiC Discs, 8"x2 1/2", PSA back, grit 60	100/box	AM0270
SiC Discs, 8"x2 1/2", PSA back, grit 120	100/box	AM0271
SiC Discs, 8"x2 1/2", PSA back, grit 180	100/box	AM0273
SiC Discs, 8"x2 1/2", PSA back, grit 240	100/box	AM0275
SiC Discs, 8"x2 1/2", PSA back, grit 320	100/box	AM0277
SiC Discs, 8"x2 1/2", PSA back, grit 400	100/box	AM0279
SiC Discs, 8"x2 1/2", PSA back, grit 600	100/box	AM0281
SiC Discs, 8"x2 1/2", PSA back, grit 800	100/box	AM0283
SiC Discs, 8"x2 1/2", PSA back, grit 1200	100/box	AM0284

## SILICON CARBIDE • WET OR DRY • PLAIN BACK

10 Inch (254 mm) • No Hole • C Weight

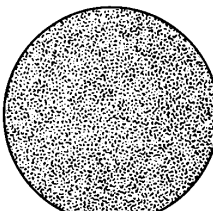

10 Inch (254 mm)  
Plain Back  
No Hole

DESCRIPTION	UNIT	CATALOG NO.
SiC Discs, 10"xNH, Plain back, grit 60	100/box	AM2120
SiC Discs, 10"xNH, Plain back, grit 80	100/box	AM2121
SiC Discs, 10"xNH, Plain back, grit 120	100/box	AM2122
SiC Discs, 10"xNH, Plain back, grit 180	100/box	AM2123
SiC Discs, 10"xNH, Plain back, grit 240	100/box	AM2124
SiC Discs, 10"xNH, Plain back, grit 320	100/box	AM2125
SiC Discs, 10"xNH, Plain back, grit 400	100/box	AM2126
SiC Discs, 10"xNH, Plain back, grit 600	100/box	AM2127
SiC Discs, 10"xNH, Plain back, grit 800	100/box	AM2128
SiC Discs, 10"xNH, Plain back, grit 1200	100/box	AM2129

# CROSS REFERENCE

ALPHA	BUEHLER®	LECO®	ALPHA	BUEHLER®	LECO®	ALPHA	BUEHLER®	LECO®
AM0901	40-6259	810-882	AM1161		811-563	AM1801		15-6830
AM0906	40-6138		AM1162		811-563	AM1802		15-6815
AM0907	40-6128		AM1163	20-8130	811-563	AM1803		15-6809
AM0908	40-6152		AM1164	20-8130	811-563	AM1804		15-6806
AM0909	40-6142		AM1165	20-8132	811-563	AM1805		15-6803
AM0910	40-6172		AM1166	20-8132	811-563	AM1806		15-6801
AM0911	40-6162		AM1167		811-563	AM1807		15-6795
AM0916			AM1168		811-563	AM1811		
AM0917			AM1169	20-8136	811-563	AM1812		
AM0918			AM1170	20-8138	811-563	AM1813		
AM0919			AM1201	20-3560	811-201	AM1814		
AM0995		813-090	AM1202	20-3562	811-202	AM1815		
AM0996	60-3255		AM1203	20-3564	811-203	AM1816		
AM1002	40-6016	811-002	AM1204			AM1817		
AM1003	40-6032	811-003	AM1205	20-3568		AM2080		
AM1004	40-6064	811-004	AM1206	20-3566		AM2081		
AM1006	40-6016	811-002	AM1207			AM2082		
AM1007	40-6032	811-003	AM1208			AM2083		
AM1008	40-6064	811-004	AM1209			AM2084		
AM1010	40-6530	810-998	AM1271	20-3046	811-271	AM2085		
AM1012	40-6531	810-997	AM1275	20-8177	811-275	AM2086		
AM1014	40-6532	810-996	AM1279		811-279	AM2087		
AM1016	40-6533	810-995	AM1300			AM2090		812-202
AM1018	40-6534	810-994	AM1301	20-3111	811-301	AM2091	30-5125	812-204
AM1020			AM1302	20-3111	811-302	AM2092	30-5125	812-206
AM1022	40-6370	812-110	AM1303		811-303	AM2093		
AM1022S	40-6370	812-121	AM1304			AM2093	30-5125	812-208
AM1023	11-1193	811-023	AM1305	20-3112	811-305	AM2094	30-5125	812-210
AM1024	11-1193	811-024	AM1306	20-3112	811-306	AM2095		
AM1031	40-3200		AM1307		811-307	AM2095	30-5125	812-212
AM1035	10-4110	811-035	AM1308			AM2096		
AM1036	10-4112	811-037	AM1309	20-3113	811-309	AM2096	30-5125	812-214
AM1037	10-4116	811-043	AM1310	20-3113	811-310	AM2097	30-5125	812-218
AM1049	10-4120	811-049	AM1311		811-311	AM2098	30-5125	812-220
AM1050		811-061	AM1312			AM2099		
AM1051	10-4220	811-073	AM1313	20-3211	811-313	AM2099		
AM1052	10-4140	811-053	AM1314	20-3211	811-314	AM2100		
AM1053	10-4145	811-053	AM1315		811-315	AM2100	30-5121	810-291
AM1059	10-4210	811-059	AM1316			AM2101		
AM1061	10-4212	811-059	AM1317	20-3212	811-317	AM2101		
AM1065	10-4410	811-065	AM1318	20-3212	811-318	AM2102		
AM1066	10-4440	811-102	AM1319		811-319	AM2102	30-5121	810-292
AM1067	10-4216	811-067	AM1320			AM2103	30-5121	810-293
AM1080	10-4427		AM1321	20-3213	811-321	AM2104		
AM1081	10-4412		AM1322	20-3213	811-322	AM2104	30-5121	810-294
AM1083		811-081	AM1323		811-323	AM2105	30-5121	810-295
AM1089	10-4416	811-089	AM1324			AM2106		
AM1095	10-4420	811-095	AM1325	20-3311	811-325	AM2106	30-5121	810-296
AM1103			AM1326	20-3311	811-326	AM2107		
AM1104	10-4445	811-104	AM1327		811-327	AM2107	30-5121	810-297
AM1105			AM1328			AM2108		
AM1106			AM1329	20-3312	811-329	AM2108	30-5542	810-856
AM1107			AM1330	20-3312	811-330	AM2109	30-5542	810-857
AM1108	10-3330	811-108	AM1331		811-331	AM2120	30-5125	812-201
AM1109	10-3330	811-109	AM1332			AM2121		
AM1110	75-6000	810-697	AM1333	20-3313	811-333	AM2122		
AM1111	20-3100	811-111	AM1334	20-3313	811-334	AM2122	30-5125	812-203
AM1118	20-3200	811-118	AM1335		811-335	AM2123	30-5125	812-205
AM1123	20-3300	811-123	AM1500	69-3173		AM2124	30-5125	812-207
AM1128		811-128	AM1501	69-3172		AM2125	30-5125	812-209
AM1133	20-3400	811-133	AM1502			AM2126		
AM1135		811-135	AM1503	69-3171		AM2126	30-5125	812-211
AM1136	11-4265	811-136	AM1504	69-3170		AM2127		
AM1137	11-4264	811-137	AM1510			AM2127	30-5125	812-213
AM1138	11-4263		AM1511			AM2128	30-5125	812-217
AM1139	20-3385	611-139	AM1512			AM2129	30-5125	812-219
AM1140			AM1513			AM3018	20-8181	810-990
AM1142		811-037	AM1514			AM3019	20-8182	810-991
AM1143		611-138	AM1634	30-7508	811-634	AM3020	20-8183	810-992
AM1144			AM1635	30-7512	811-635	AM4025		
AM1145			AM1636	30-7510		AM7052	40-7052	
AM1146		811-146	AM1724	11-2490	801-724	AM7212	40-7212	
AM1147			AM1725	10-4000		AM7602		

All of Alpha's products are manufactured and/or supplied by Alpha Resources, Inc. The reference to competitor's names and part numbers is for comparison and convenience purposes only. Alpha does not imply that its products are supplied by the named companies, but that they are deemed suitable as direct replacements, are of high quality and appropriate for all named instrumentation.

Can't find the item(s) you need? **Alpha is continually adding products** to this list. If you can't find the part you need, **contact Alpha today** for our latest Alpha/Buehler®/LECO® Cross Reference. **Alpha appreciates your business!**



## ABRASIVE STRIPS

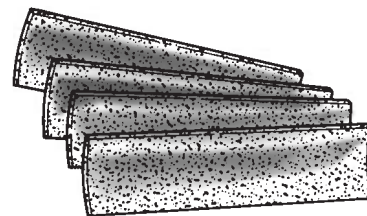

Strips

### ABRASIVE STRIPS

#### SILICON CARBIDE • WET OR DRY • PSA BACK

3 Inch (76 mm) x 11 Inch (279 mm) • C Weight

DESCRIPTION	UNIT	CATALOG NO.
SiC 3"x11", grit 180	100/Pkg.	AM0160
SiC 3"x11", grit 240	100/Pkg.	AM0161
SiC 3"x11", grit 320	100/Pkg.	AM0162
SiC 3"x11", grit 400	100/Pkg.	AM0163
SiC 3"x11", grit 600	100/Pkg.	AM0164

#### SILICON CARBIDE • WET OR DRY • PSA BACK

6 Inch (152 mm) x 11 Inch (279 mm) • C Weight

DESCRIPTION	UNIT	CATALOG NO.
SiC 6"x11", grit 180	100/Pkg.	AM0165
SiC 6"x11", grit 240	100/Pkg.	AM0166
SiC 6"x11", grit 320	100/Pkg.	AM0167
SiC 6"x11", grit 400	100/Pkg.	AM0168
SiC 6"x11", grit 600	100/Pkg.	AM0169



**IMPTECH PG-10**  
Single Wheel Polisher/Grinder  
ALPHA Part Number IPM 10VA

**IMPTECH D-10**  
Automatic Fluid Dispensing Unit  
ALPHA Part Number D10001



**IMPTECH PH-12**  
Automatic Polisher/Grinder Head  
ALPHA Part Number IHMPH12

**IMPTECH PG-20**  
Double Wheel Polisher/Grinder  
ALPHA Part Number IPM 20VA

The IMPTECH Polisher/Grinder comes as either a single or double wheel unit. These Polisher/Grinders can be ordered with either an 8 inch (203 mm) or 12 inch (305 mm) working wheel. These working wheels come in an assortment of materials including Aluminum, PVC or Brass. Another desirable feature for the Polisher/Grinder is the IHMPH12 polishing head. It utilizes independent pistons to correctly control the pressure applied to each sample as it polishes as well as automatic control of the wheel direction, polishing time and more. The IHMPH12 comes already installed and should be ordered at the same time as the Polisher/Grinder.

ORDER TOLL FREE - 1-800-833-3083  
OR PHONE 269-465-5559 - FAX 269-465-3629  
ALPHA APPRECIATES YOUR BUSINESS

## ABRASIVE DISCS



### ALPHAGRAB® DISC

The AlphaGrab® is a two sided abrasive disc grit grabber. One side attaches to your working wheel while the other side will adhere non-coated working discs such as abrasive coated papers. The AlphaGrab® lasts up to 30 changes and is an economical way to save you both time and money. These are available for all uncoated size papers, 8", 10" and 12", and are packaged in quantities of 10 discs per package.

DESCRIPTION	UNIT	CATALOG NO.
AlphaGrab® Disc, 8"	10/Pkg.	AM1634
AlphaGrab® Disc, 10"	10/Pkg.	AM1636
AlphaGrab® Disc, 12"	10/Pkg.	AM1635

### ABRASIVE DISCS

#### SILICON CARBIDE • WET OR DRY • PLAIN BACK

8 Inch (203 mm) Diameter • No Hole • C Weight

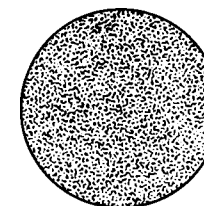

8 Inch (203 mm)  
Plain Back  
No Hole

DESCRIPTION	UNIT	CATALOG NO.
SiC Discs, 8"xNH, plain back, grit 60	100/box	AM0217
SiC Discs, 8"xNH, plain back, grit 80	100/box	AM0218
SiC Discs, 8"xNH, plain back, grit 120	100/box	AM0219
SiC Discs, 8"xNH, plain back, grit 180	100/box	AM0221
SiC Discs, 8"xNH, plain back, grit 240	100/box	AM0223
SiC Discs, 8"xNH, plain back, grit 320	100/box	AM0225
SiC Discs, 8"xNH, plain back, grit 400	100/box	AM0227
SiC Discs, 8"xNH, plain back, grit 600	100/box	AM0229
SiC Discs, 8"xNH, plain back, grit 800	100/box	AM0035
SiC Discs, 8"xNH, plain back, grit 1200	100/box	AM0036

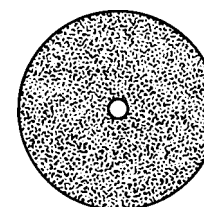

8 Inch (203 mm)  
1/2 Inch (13 mm) Hole  
Plain Back

#### SILICON CARBIDE • WET OR DRY • PLAIN BACK

8 Inch (203 mm) x 1/2 Inch (13 mm) Hole • C Weight

DESCRIPTION	UNIT	CATALOG NO.
SiC Discs, 8"x1/2, plain back, grit 60	100/box	AM0231
SiC Discs, 8"x1/2, plain back, grit 80	100/box	AM0232
SiC Discs, 8"x1/2, plain back, grit 120	100/box	AM0233
SiC Discs, 8"x1/2, plain back, grit 180	100/box	AM0235
SiC Discs, 8"x1/2, plain back, grit 240	100/box	AM0237
SiC Discs, 8"x1/2, plain back, grit 320	100/box	AM0239
SiC Discs, 8"x1/2, plain back, grit 400	100/box	AM0241
SiC Discs, 8"x1/2, plain back, grit 600	100/box	AM0243
SiC Discs, 8"x1/2, plain back, grit 800	100/box	AM0242
SiC Discs, 8"x1/2, plain back, grit 1200	100/box	AM0244

Can't find the product you need? Call ALPHA today at  
**1-800-833-3083**